

THE ORIGINAL GRATE HEATER



Installation and Operating Instructions

The Grate Heater can be used in a wood-burning masonry fireplace with any set of glass doors and features a concealed blower that retains the natural beauty of your fireplace. With proper care and maintenance, the Grate Heater is a safe and efficient insert for your fireplace.

This unit is recommended for use with a glass door enclosure. Using the Grate Heater in conjunction with glass doors produces maximum performance from the fireplace and presents a lower operating fuel cost.

Model	Width	Depth	Weight
2017	20 in.	17 in.	48 lbs.
2220	22 in.	20 in.	52 lbs.
2422	24 in.	22 in.	56 lbs.

INSTALLATION INSTRUCTIONS:

All units come with a front grill 1-3/4 inch high and 48 inches wide. This unit will force more heated air into the room and allow a more comfortable temperature during the brisk winter months by having one (1) venting outlet.

After installing, avoid building a raging fire in the fireplace. The fan will distribute more heat directly to the room if the burn cycle is even. Overfiring can cause discoloration to any glass door unit and may damage the heat exchanger.

Step 1.

Verify that the Grate Heater is the proper size for the fireplace.

Step 2.

For fireplaces with existing glass doors, make sure they can be elevated 1-3/8 inch. Remove the glass doors. Insert the Grate Heater and reposition the glass door on top of the riser bar. This will elevate the glass door 1-3/8 inch.

Step 3.

Mount extender bars on the heat exchanger with the metal screws provided (see Figure 1).

Step 4.

Place the glass door enclosure on the front of the exchanger, making sure the glass door and heat exchanger are centered in the fireplace.

Step 5.

Remove the extender bars and cut them so the total riser bar width is the same as the glass enclosure. Cut the cord shield to the desired length and slide it on the extender bar where cord is introduced (this protects the cord from heat). Place the end caps on the ends of the extender bars with the notched cap on the cord side (see Figure 1).

Step 6.

Reposition and secure the glass door according to the glass door instruction manual.

Step 7.

For a dropped hearth installation, the back legs come standard with 1/2 inch nuts and it is recommended that 1/2 inch x 2-1/2 inch bolts be used. (Not included).

Step 8.

Plug cord into nearest outlet. Exchanger will start when temperature reaches 110° F and turn off at 90° F.

Note: Grate heater fan should be plugged in at all times when the unit is in use, otherwise damage to the motor will occur.

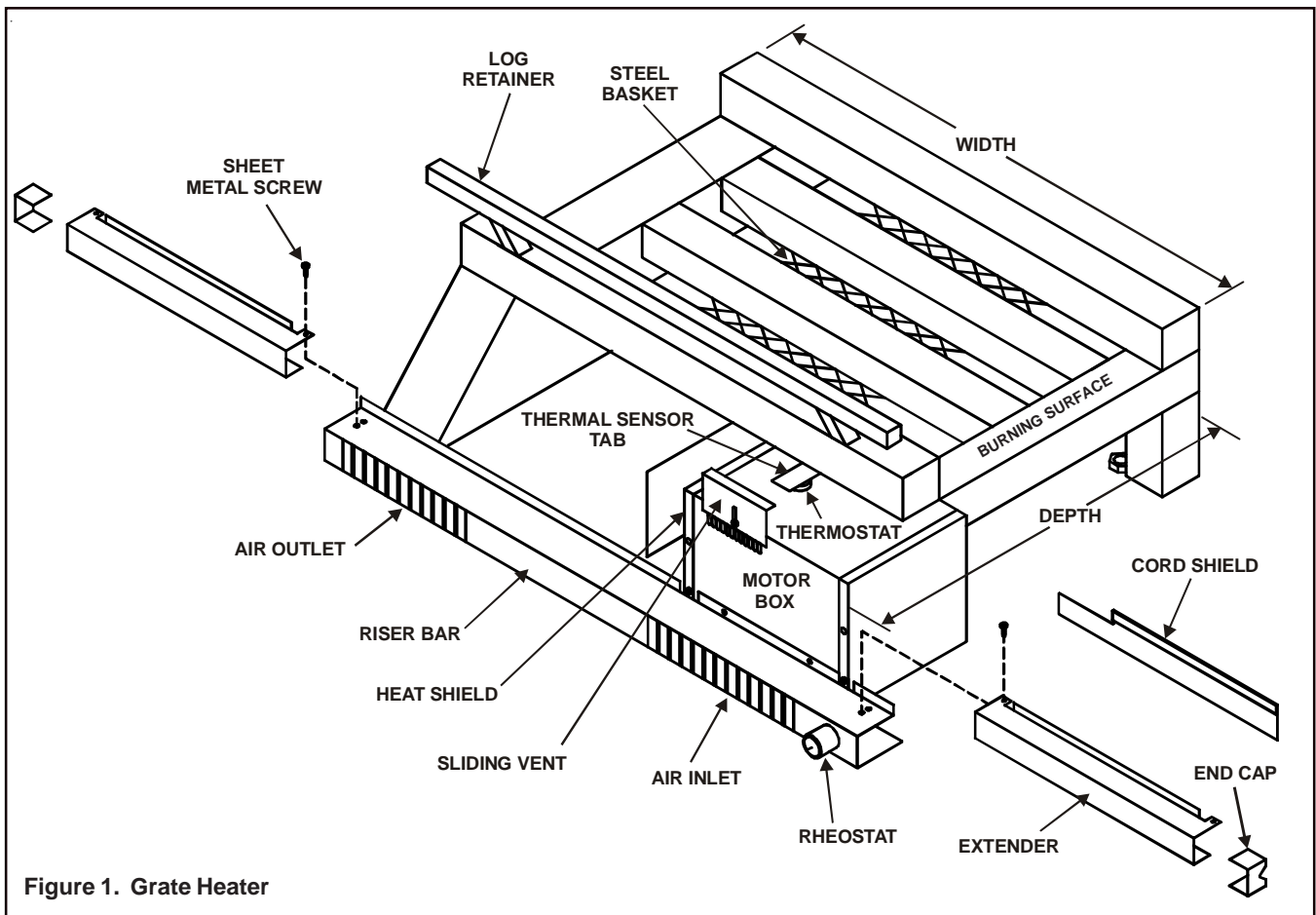

Figure 1. Grate Heater

OPERATING INSTRUCTIONS

1. On initial start-up of the Grate Heater, there will be some smoke produced. This is a burn-off of oil used in manufacturing of this unit. The smoke will subside after the first firing. The fan should be left on low speed, with the fireplace doors open. The smoke can be minimized by placing a damp cloth over the heat outlet.
2. The blower sliding vent should only be open when glass doors are not used or in the event of a power failure or blackout. Under these conditions the vent is used to cool the blower.
3. This unit is equipped with a three (3) wire ground cord for protection. **Never** remove the ground lead. Be sure the electrical plug provided is plugged into a proper three (3) prong outlet. If an extension cord is used, be sure it has the proper ground and is of the same or greater value than the cord provided on the Grate Heater. If the extension cord is too light the fan may fluctuate its speed and operate improperly.
4. Periodic removal and cleaning of ashes on the square tubing will increase heat output and maximize efficiency.

5. Under normal use the blower on the Grate Heater should be oiled every 4,000 hours of operation. There is an opening on the top of the motor where the lubricant can be applied (see Figure 2).

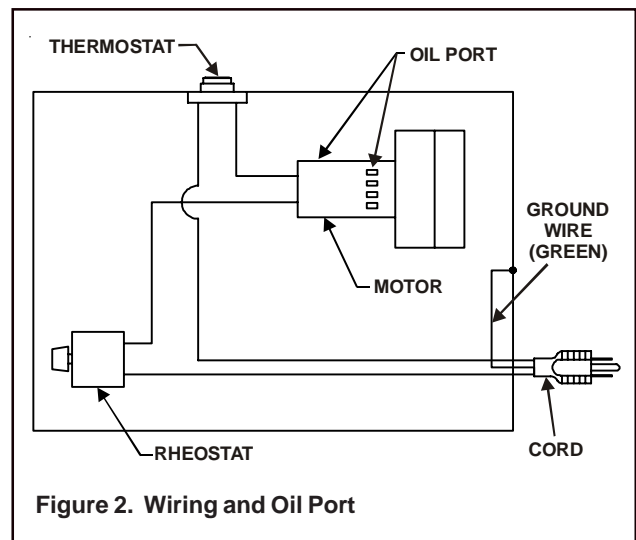

Figure 2. Wiring and Oil Port

TROUBLESHOOTING

1. Blower will not turn on.

If a fire has not been started on the heat exchanger, the fan will not come on. Because the Grate Heater is thermostatically controlled, it will not turn on until the thermostat, located on the top of the motor box, reaches 110° F. After you start the fire it will normally take 15 to 30 minutes before the fan will turn on. The blower will automatically turn off at a temperature of 90° F.

2. Blower turns on and off while fire is burning.

Check the thermal sensor tab which is 1 inch wide and 4 inches long, located on the top of the motor box, extending over the thermostat (see Figure 1). It conducts the heat from the Grate Heater to the sensor so the motor is activated. If the motor is starting and stopping, you may need to tighten this tab so it is touching the thermostat. This can be done with a standard screwdriver. Tighten the tab only so it is touching the thermostat. **Do not overtighten.**

3. Motor hums upon starting.

Be sure the Grate Heater is **unplugged** before checking for potential problems.

Remove the left side panel of the motor box by taking out the front screw of the motor box. (There is a screw on the backside, but it is only a guide to hold the panel in place). Push forward and the panel will come free. After removing this panel check to see if the motor is in place. Two (2) sheet metal screws top and bottom hold the motor in the housing. If one of the screws has come loose (from vibration) the motor cannot turn freely. To correct this, reattach the two (2) screws which will secure the motor and allow it to turn freely.

4. Blower will not turn on after the fire has been started.

If the motor does not turn on after starting a fire, several items can be checked. Be sure the unit is **unplugged** before checking for potential problems.

Check the thermal sensor as indicated in Step 2.

Check the motor and the wiring to the motor. The motor must be free to turn and the wiring must be intact and attached to both the thermostat and the rheostat. If you notice that any of the wires coming from the motor are bare, it will be necessary to replace the motor. This can be done by removing the two (2) screws that attach the motor to the housing.

If the problem is in the thermostat, the thermostat must be replaced. The thermostat is held in place by two (2) rivets which can be drilled out from the top with a 1/8 inch drill bit. When replacing the thermostat use either rivets or sheet metal screws to hold it in place.

The rheostat, the speed control in the front of the heater, may also need to be replaced if it is operating improperly. To remove the rheostat, take the knob off and then loosen the screw on the front of the heater. Using a pair of pliers, release the heyco connector or stress relief (located on the right side of the front, behind the extender) so the wiring to the rheostat is free. Unplug the connectors and replace the rheostat.

With proper care and maintenance, your Grate Heater should give you years of efficient heat circulation while maintaining the natural beauty of your fireplace.

WARRANTY

The Original Grate Heater has a full three-year warranty from the date of purchase on square tubing and a one year on all electrical components. Units must be operated in accordance with operating instructions. Damage due to shipping, abuse or misuse is not covered. Cost of return shipping is also not covered.

SERVICE PARTS LIST

DESCRIPTION	SERVICE PART NO.
Blower Motor	SRV01-500
Rheostat	SRV01-510
High Limit Switch	SRV01-531
Replacement Cord	SRV01-550