

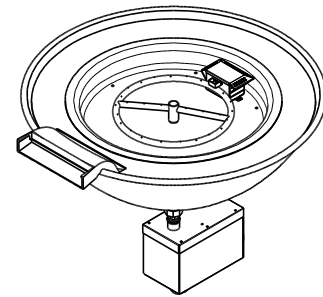

**Hearth Products Controls Co**  
**CSA CERTIFIED FIRE PIT INSERT**  
**OUTDOOR USE ONLY**

HEARTH PRODUCTS CONTROLS  
 3050 PLAINFIELD RD.  
 KETTERING, OH 45432  
 TOLL FREE: 1-877-433-7001  
 PHONE: (937) 433-7000  
 FAX: (937) 433-0704  
 www.hpcfire.com

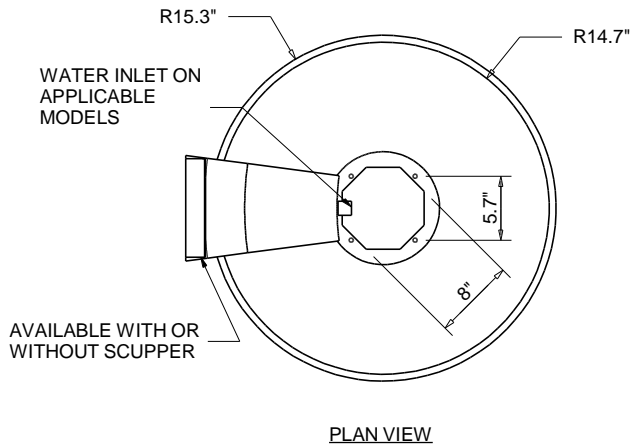

**ISOMETRIC VIEW**

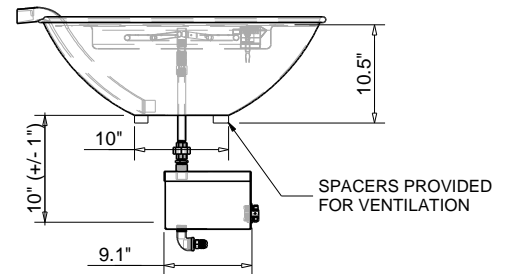

**ELECTRONIC IGNITION OPTION**

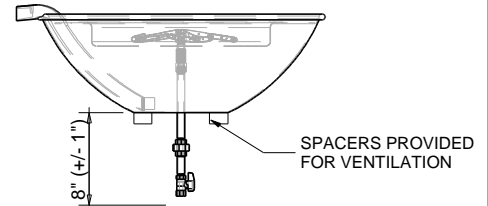

**MATCH LIT OPTION**

PART NUMBER	WATER SCUPPER	IGNITION	STND BTU	VOLTAGE
TEMP31-HWI	NO	ELECTRONIC	65K	120VAC/24VAC
TEMP31W-HWI	YES	ELECTRONIC	65K	120VAC/24VAC
TEMP31-MLFPK	NO	MATCH LIT	50K	-
TEMP31W-MLFPK	YES	MATCH LIT	50K	-

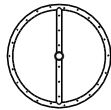

**ROUND BURNER**

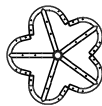

**PENTA BURNER**

**Notes:**

1. FOR USE WITH FIXED PIPING SYSTEMS ONLY.
2. NOT FOR USE WITH SMALL TANKS.
3. ALL ENCLOSURES REQUIRE 2 each 18 SQ/IN VENTS ON OPPOSING SIDES AND ADEQUATE DRAINAGE.
4. RESIDENTIAL GAS PRESSURE ONLY. (NG- 7.0" WC, LP- 11.0" WC)
5. MODIFICATION OF PRODUCT WILL VOID ANY CERTIFICATION AND WARRANTY.
6. FOLLOW ALL MANUFACTURER INSTALLATION INSTRUCTIONS AND LOCAL CODES.
7. ALL DIMENSIONS ARE CONSIDERED TRUE AND REFLECT MANUFACTURER'S SPECIFICATIONS AS OF THE REVISION DATE.
8. DO NOT SCALE DRAWING.
9. THESE DRAWINGS ARE FOR SIZING AND PLANNING PURPOSES. ALL INFORMATION CONTAINED HEREIN WAS CURRENT AT THE TIME OF DEVELOPMENT. THE MANUFACTURE IS RESPONSIBLE FOR THE ACCURACY OF THE DRAWING.
10. CONTRACTOR'S NOTE: FOR PRODUCT AND COMANY INFORMATION VISIT [www.CADdetails.com/info](http://www.CADdetails.com/info) REFERENCE NUMBER 771-019.

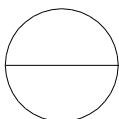

TEMPE WITH HWI FIRE PIT- FLAME SENSING WITH ELECTRONIC HOT WIRE IGNITION  
 TEMPE WITH MATCH LIT FIRE PIT INSERT