

The Sonoma fire pit is handmade by Dekko in North America. Ships with your choice of NG or LP burner, one decorative aggregate option and chrome On/Off key.

Size: 72"W x 33"D x 16"H
 CSA/UL Approved Burner Assembly



	Manual Ignition	Electronic Ignition
BTU/Hr	65,000	150,000
Weight	215 lbs	215 lbs
Fuel Options	NG/LP	NG/LP

Optional Accessories:

- Propane Tank Cover 16"W x 16"D x 21"H
- Glass Wind Guard 55"W x 15"D x 6"H
- Vinyl Weather Cover
- Powder Coated Aluminium Table Top 72"W x 33"D

Colour Options

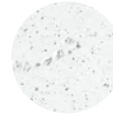

NATURAL

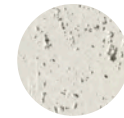

LIMESTONE

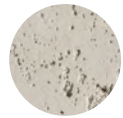

CLAY

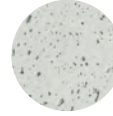

ASH

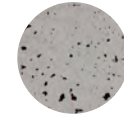

SANDSTONE

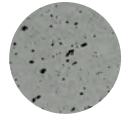

CHARCOAL

Decorative Aggregate Options



IVORY BEACH STONE



SLATE BEACH STONE



BLACK LAVA ROCK

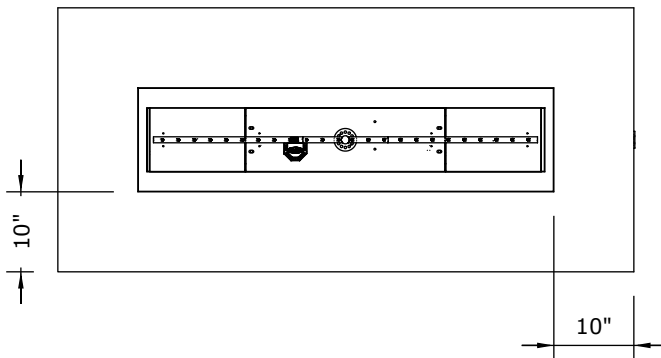

PLAN VIEW

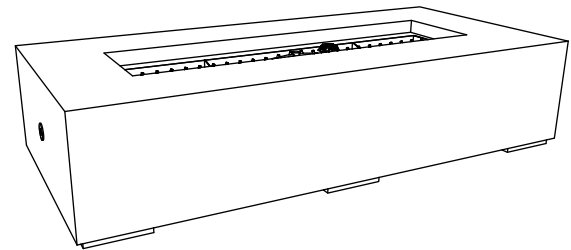

PERSPECTIVE VIEW

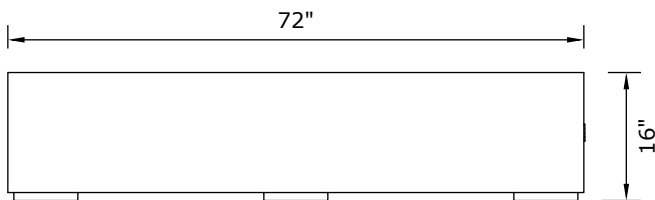

FRONT ELEVATION

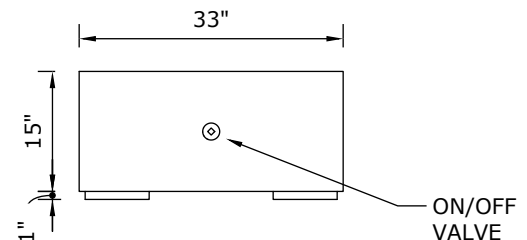

SIDE ELEVATION



Clearances

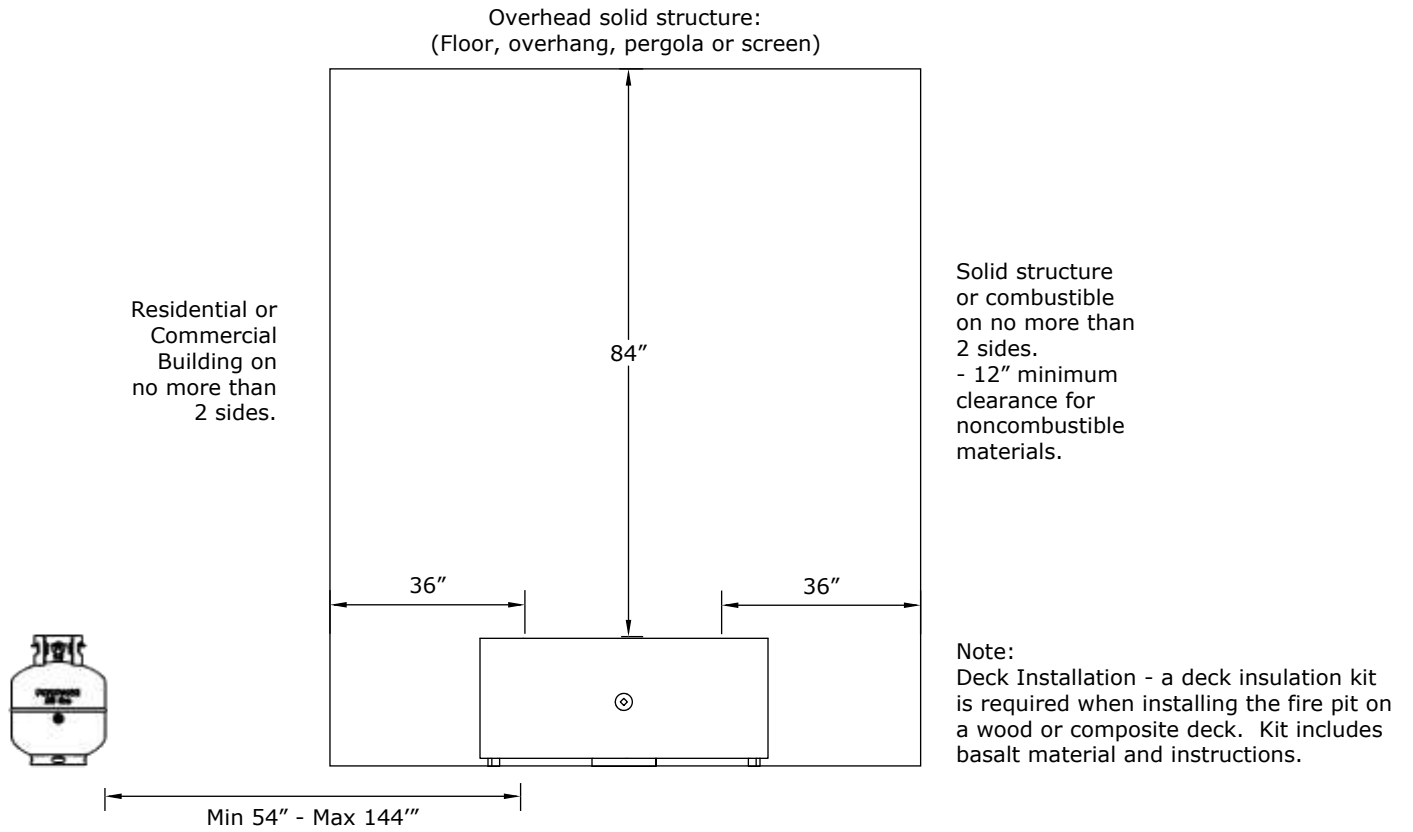

Burner Assembly

49" Match Lit Burner

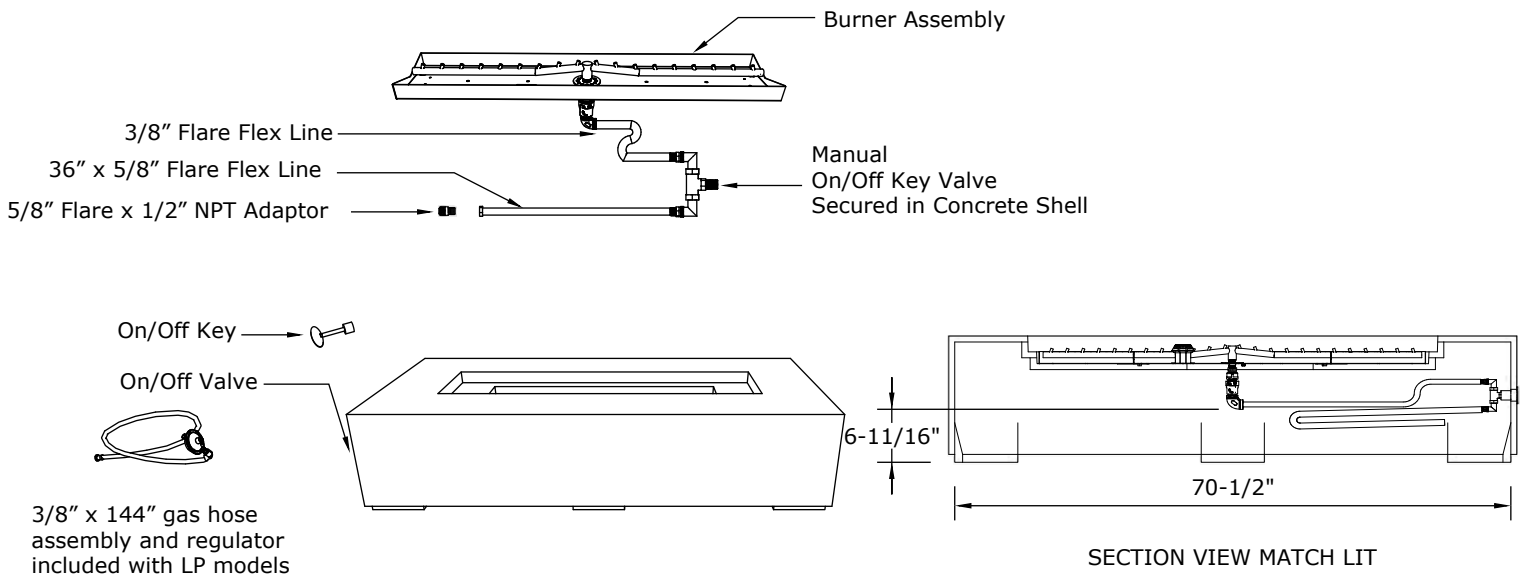



Clearances:

Overhead solid structure:
(Floor, overhang, pergola or screen)

Residential or Commercial Building on no more than 2 sides.

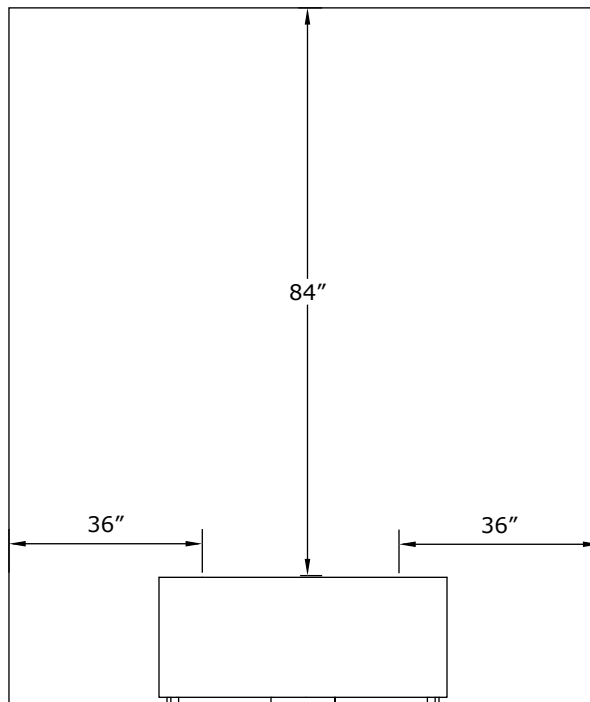

Solid structure or combustible on no more than 2 sides.
- 12" minimum clearance for noncombustible materials.

Note:

Electronic ignition burners require a fixed piping gas supply. Not for use with portable LP tanks.

Note:

Deck Installation - if installing fire pit on a wood or composite deck, it is required to use the deck insulation kit. Kit includes basalt material and instructions.

Burner Assembly

Electrical:

120V Outdoor receptacle required. Must be installed and grounded in accordance with local codes.

49" Electronic Ignition Burner

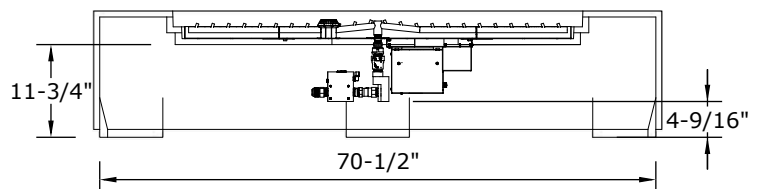
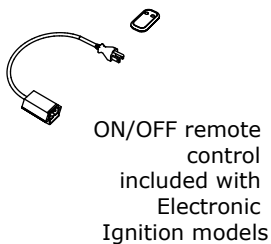
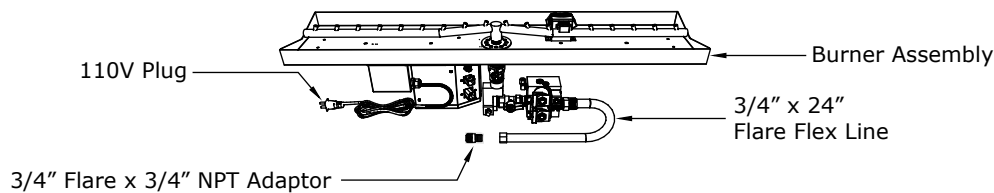

SECTION VIEW ELECTRONIC IGNITION