



THE OUTDOOR
GREATROOM
COMPANY

The Cove Fire Pit

Installation Instructions for Linear Cove Fire Pits
CVL-48, CVL-84, CVL-96



IMPORTANT

DO NOT ATTEMPT TO INSTALL CRYSTAL FIRE BURNER WITHOUT FIRST CONSULTING THE CRYSTAL FIRE OWNER'S MANUAL.

Please consult your Crystal Fire instruction manual for detailed instructions and important information related to the burner installation including lighting and operating instructions, safety information, and proper tightening of connections with two wrenches.

ENCLOSURE DESIGN REQUIREMENTS

The ventilation requirements for natural gas and propane hard-piped installations in the Crystal Fire Plus manual are intended for enclosures not designed and tested by The Outdoor GreatRoom Company and do not apply to The Cove Fire Pits.

Contents

Required Tools.....	3
Included with your Fire Pit.....	3
Assembly Instructions.....	4
Sparker Installation.....	4
Gas Connections.....	5
Electrode Connection.....	5
Burner Installation.....	6
Propane tank installation.....	6
Fire Glass Installation.....	7
Frequently Asked Questions.....	8
Maintenance	9
Service Parts	11
Warranty.....	12

Required Tools

FOUR people are required for this installation.



- **2 Open Ended Wrenches**
To secure gas connections.
- **Leather Gloves**
To protect hands from rough edges found on fire pit during installation.
- **One AAA Battery (not included)**
Required for electric spark igniter installation.
- **Utility Knife**
To cut and remove packaging.
- **Power Drill**
To remove support board from crate.

Included With Your Fire Pit

CVL-48 / CVL-84/CVL-96

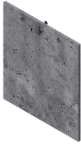
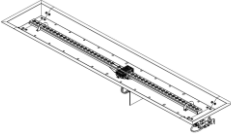
	<p style="text-align: center;">Cove Linear Base with Control Panel Installed</p>
	<p style="text-align: center;">CVL-48 model only (CV-DOOR)</p>
	<p style="text-align: center;">CFP1224/DSING/DSILP-B, CFP1264/DSING/DSILP-B, CFP1272/DSING/DSILP-B</p>

Refer to Crystal Fire® Plus Manual for items included with Crystal Fire® Plus burners.

Assembly Instructions

- **Remove Cove Fire Pit Base from Packaging crate**
 - Four People are required to lift base out of packaging and place into final location.



See your Crystal Fire Plus Owner's Manual for gas and electric requirements for electronic ignition (DSI) burners.

- **Sparker Installation**
 - Remove sparker cap and hex nut. Insert AAA battery (not included) with + end out.
 - Install sparker into control panel as shown below, secure using hex nut and replace sparker cap.
 - Depress sparker button to ensure your sparker is working properly. You should hear the spark behind the sparker box.

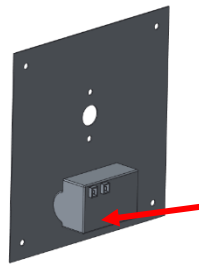
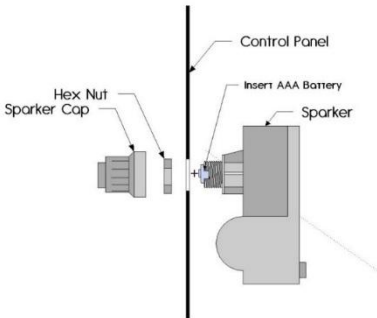

Locate and orient sparker box on control panel as shown. Sparker box must be installed **before** burner valve.

- **Gas Connections**

Read and understand your Crystal Fire Burner Owner's manual before beginning burner hookups or using the device. Do not use Teflon tape or pipe dope on flare fittings.

- **See Crystal Fire® Plus instructions for burner installation.**
 - All gas connections were completed at the factory.
- Check all connections for leaks. If needed, tighten connection with 2 wrenches and re-check for leaks.
- Attach burner valve to control panel with provided screws as shown below. Ensure sparker box is installed before this step.

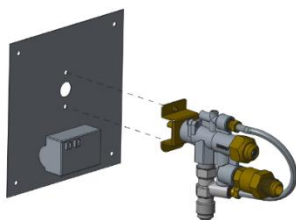

- **Connect Ground wire and Electrode wire from burner to sparker.**

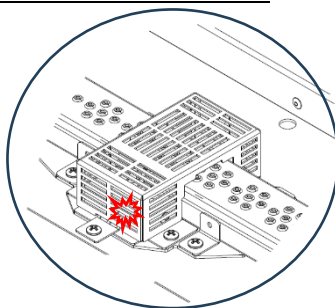
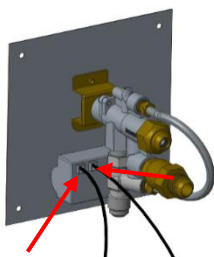

- Connect ignitor and ground wire to sparker box. Both wires can connect to either connection point. The unit will operate in either configuration.
- Test system by pushing the button on the igniter. Consult the troubleshooting section of the Crystal Fire® Plus Burner Owner's Manual, if the spark is weak, intermittent, or not present.

- **Drop burner into base.**

CVL-48/CVL-84/CVL-96

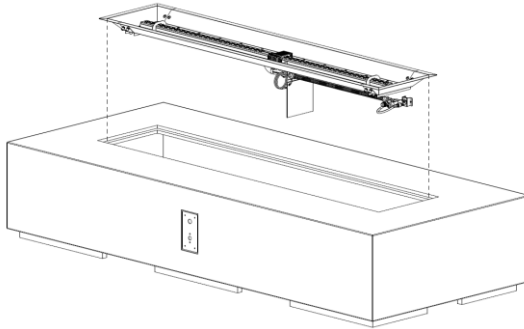

- Place burner assembly into recessed opening in base.

- **Propane Tank Installation (CVL-48 only)**



- With the propane tank valve and key valve off, attach the propane regulator to the propane tank. **Hand tighten, do not use a wrench for this connection.**



- Lift and tilt the propane tank through the access door into place underneath the base. Ensure that all hoses and wires are kept away from the hot burner surfaces.

Use caution not to chip the edges of the concrete when installing the tank.



- Install the door by setting the door bottom bracket on the pins in the base and tilting it into place. Secure by turning the ¼ turn cam lock to lock the door in place.

- **Install Fire Media**

- Scatter all included glass beads, lava rock, or other approved fire media evenly across entire burner surface.

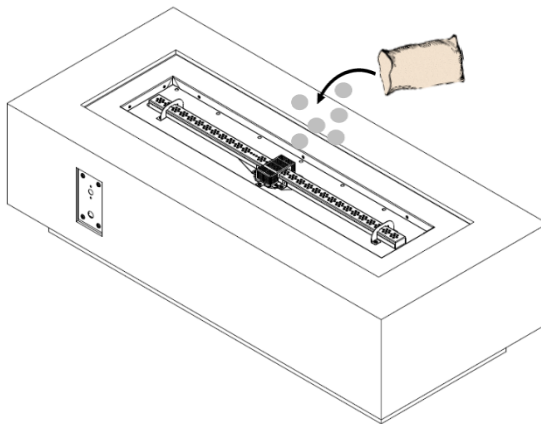

**DO NOT OPERATE CRYSTAL FIRE® PLUS BURNER
WITHOUT INCLUDED GLASS BEADS OR OTHER
APPROVED FIRE MEDIA**

IMPORTANT

Please consult your Crystal Fire instruction manual for detailed instructions and important information related to the burner installation including: lighting and operating instructions, safety information, and proper tightening of connections with two wrenches.

DO NOT ATTEMPT TO INSTALL CF-1242 BURNER WITHOUT FIRST CONSULTING THE CRYSTAL FIRE OWNER'S MANUAL.

WARNING

After consulting the manual and following instructions, remember; before operating, all gas connections must be fully checked for leaks

Frequently Asked Questions

What is Supercast?

Supercast is a proprietary blend of fiber glass and polymer fortified concrete. This guide will help inform you about some unique characteristics of a Glass-Fiber reinforced concrete top and help you keep it looking like new for years to come.

Supercast Glass Fiber Reinforced Concrete (GFRC) Products Warranty Information.

- One year warranty on structure and finish. Cracks that exceed 1/8" displacement in either height or gap and determined to be a product of either material or workmanship, shall be warrantied for a period of 1 year. Non-structural hairline cracks are possible and shall not be considered a manufacturing defect.
- Natural variations in color, shade, porosity, pitting and texture may occur with GFRC products and are considered inherent and valued qualities of the material. Variation in shape and dimension can be up to $\pm 1/4"$.
- Under most conditions, re-sealing is suggested every 1-2 years using a clear matte finish solvent based concrete sealer. The frequency is dependent on ambient conditions including, but not limited to frequency of use, exposure to UV, saltwater, chlorine, hard water, air temperature, and humidity.
- If covering a GFRC item, use a one-way breathable cover as supplied by The Outdoor GreatRoom Company, LLC (OGC) or equivalent. Do not use other materials or objects to hold down or secure a protective cover on top or around the GFRC item.

- While maintaining a regular re-sealing maintenance schedule in combination with using a one-way breathable cover, the color of a GFRC item will fade minimally over time and should not require re-staining or re-coloring. If re-staining, contact OGC for an approved stain type and color.
- When used in conjunction with a Crystal Fire Plus burner setup, all custom GFRC products are required to operate with an OGC glass guard installed around the burner. The glass guard improves the flame appearance and reduces the risk of unnecessary thermal stress on the GFRC surface. A glass guard is recommended for stock GFRC products.

What makes a concrete fire pit unique?

Your fire pit is handcrafted from Portland cement concrete and reinforced with glass fibers to provide exceptional strength and durability compared to traditional concrete. Supercast is typically 1/3 of the thickness of traditional concrete with 3 times the strength. Each piece offers its own uniqueness; you may notice color variations in your fire pit. This is intentionally done during the molding process to create a unique natural appearance which mimics natural stone.

Maintenance Instructions:

To keep your fire pit looking new, we recommend the following:

- Keep covered when not in use to protect from buildup of water, snow, dust, dirt, and debris and direct sunlight whenever possible.
- Do not put the cover on when the table is wet.
- If any colored liquids such as wine or soda are spilled on your top, clean off immediately to avoid possible staining.
 - We recommend cleaning your top regularly with a mild mixture of dish detergent and warm water; rinse thoroughly.

How do I reseal Supercast surfaces?

- First clean using a diluted solution of vinegar and water to remove any dirt or debris that may have accumulated on the surface and allow to dry.
- Reseal the surfaces using the stain/sealers below based on the color fire pit you have. Apply the stain/sealer using a foam roller and allow it to cure for 24 hours before exposing to water or use. The stain/sealers can be purchased at any Sherwin-Williams store.
- Minor surface scratches can be removed by using the stain/sealing method above. Clean the area affected and apply the stain/sealer.
- Natural Grey - MN Concrete Custom Grey: H&C Exterior Color Top solvent-based solid color sealer, Tint Base-Deep, satin sheen. The color mix is for 5 gallons, vendor can adjust color amounts based on size being purchased:

BAC Colorant	OZ	32	64	128
W1-White	4	42	-	-
B1-Black	4	47	-	-
R2-Maroon	-	15	-	-
Y3-Deep Gold	2	51	-	-

- White - MCP White: H&C Exterior Color Top solvent based solid color sealer, Tint Base-White, satin sheen. The 1 gallon color mix is:

BAC Colorant	OZ	32	64	128
B1-Black	-	2	1	-
Y3-Deep Gold	-	2	1	-

- Midnight Mist - MCP Raven: H&C Heavy Shield water based solid color enamel/stain, Tint Base-Ultradeep, semi-gloss. The 1 gallon color mix is:

BAC Colorant	OZ	32	64	128
W1-White	-	31	1	1
B1-Black	6	21	-	-
R2-Maroon	-	13	-	1
Y3-Deep Gold	-	30	-	-

- Linen – MCP xx: H&C Exterior Color Top solvent based solid color sealer, Tint Base-Extra White, semi-gloss. The 1 gallon color mix is:

BAC Colorant	OZ	32	64	128
B1 - Black	-	4	1	-
R2 - Maroon	-	1	1	-
Y3 – Deep Gold	-	13	1	-
W1 - White	2	-	-	-
L1 - Blue	-	2	-	-

- Latte – MCP Tavern Taupe: H&C Exterior Color Top solvent based solid color sealer, Tint Base-Deep, satin sheen. The 1 gallon color mix is:

BAC Colorant	OZ	32	64	128
B1 - Black	-	41	-	1
R2 - Maroon	-	8	-	1
Y3 – Deep Gold	-	49	-	1
W1 - White	-	29	-	1

- Earthstone – MCP Griffin: H&C Exterior Color Top solvent based solid color sealer, Tint Base-Deep, satin sheen. The 1 gallon color mix is:

BAC Colorant	OZ	32	64	128
B1 - Black	4	63	-	1
R2 - Maroon	-	30	1	-
Y3 – Deep Gold	4	22	1	-
W1 - White	-	11	-	1

Service Parts – Supercast base

CVL-48	3014-001-NG	Natural Grey
	3014-001-WT	White
	3014-001-LN	Linen
	3014-001-MM	Midnight Mist
	3014-001-LT	Latte
	3014-001-ES	Earthstone
CVL-48 Door	3014-010-NG	Natural Grey
	3014-010-WT	White
	3014-010-LN	Linen
	3014-010-MM	Midnight Mist
	3014-010-LT	Latte
	3014-010-ES	Earthstone
CVL-84	3014-002-NG	Natural Grey
	3014-002-WT	White
	3014-002-LN	Linen
	3014-002-MM	Midnight Mist
	3014-002-LT	Latte
	3014-002-ES	Earthstone
CVL-96 Electronic Ignition	3014-003-NG	Natural Grey
	3014-003-WT	White
	3014-003-LN	Linen
	3014-003-MM	Midnight Mist
	3014-003-LT	Latte
	3014-003-ES	Earthstone
CVL-96 Manual Ignition	3014-004-NG	Natural Grey
	3014-004-WT	White
	3014-004-LN	Linen
	3014-004-MM	Midnight Mist
	3014-004-LT	Latte
	3014-004-ES	Earthstone

Service Parts – Patch Kits

Color	Kit
Natural Grey	CV-SC-PK
White	W-SC-PK
Midnight Mist	MM-SC-PK
Linen	LN-SC-PK
Latte	LT-SC-PK
Earthstone	ES-SC-PK

Refer to Crystal Fire® Plus instruction manual for burner service parts.

Thank you for purchasing an Outdoor
GreatRoom Company product!



Warranty: Supercast Glass Reinforced Concrete
Products are covered under a 1- year manufacturer's
warranty. Please visit
[https://outdoorrooms.com/pages/product-
support__product-registration](https://outdoorrooms.com/pages/product-support__product-registration)
to register your product.

A yellow equilateral triangle with a black border and a black exclamation mark in the center.	<p>WARNING: This product can expose you to chemicals including Carbon Monoxide and Benzene which are known to the State of California to cause cancer or birth defects or reproductive harm. For more information, visit www.P65Warnings.ca.gov</p>
---	---



9583 217th St. W. • Lakeville, MN 55044
Toll Free: 1-866-303-4028 • Sales@OutdoorRooms.com