



THE OUTDOOR
GREATROOM
COMPANY

Renegade Fire Table

Installation Instructions for RNG-32



IMPORTANT

Please consult your Crystal Fire instruction manual for detailed instructions and important information related to the burner installation including: lighting and operating instructions, safety information, and proper tightening of connections with two wrenches.

DO NOT ATTEMPT TO INSTALL CRYSTAL FIRE BURNER WITHOUT FIRST CONSULTING THE CRYSTAL FIRE OWNER’S MANUAL.

Contents

Required Tools.....	3
Included with your Fire Pit.....	4
Assembly Instructions.....	5
Gas Connections.....	7
CF-SPARKER Installation.....	9
Install Fire Media.....	10
Position Your Tank.....	11
Storage.....	12

Required Tools



- Utility Knife
To cut and remove packaging



- 2 Open Ended Wrenches
To secure gas connections



- One AAA Battery (not included)
Required for electric spark igniter installation



- Phillips Screwdriver
To attach mounting screws to control panel

Included with your Fire Pit



Burner Cover [1X]

Part #: RNG-4

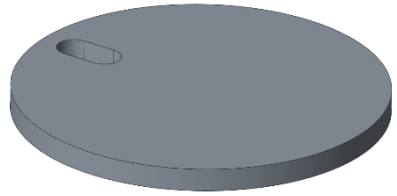

Media Retention Pad [1X]

Part #: RNG-PAD

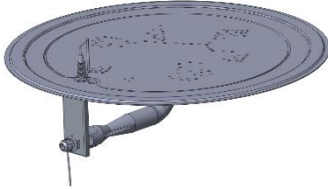

NF-16-RD Burner [1X]

Gas Valve Kit

GM-KV



Gas Valve [1X]

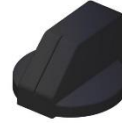

**Control knob
[1X]**



**Mounting
screws [2X]**



Leg [3X]

Part #: RNG-2



Base [1X]



Carrying Bag [1X]

Part #: CB-REN

Assembly Instructions

NOTE: Before assembly, check for damage. Do not use damaged components.

1. Unpack all the contents from the box and remove the individual packaging from each component.
2. Carefully lay the **Base**, with underside facing upwards. Check to make sure that clasps are in the **open** position.

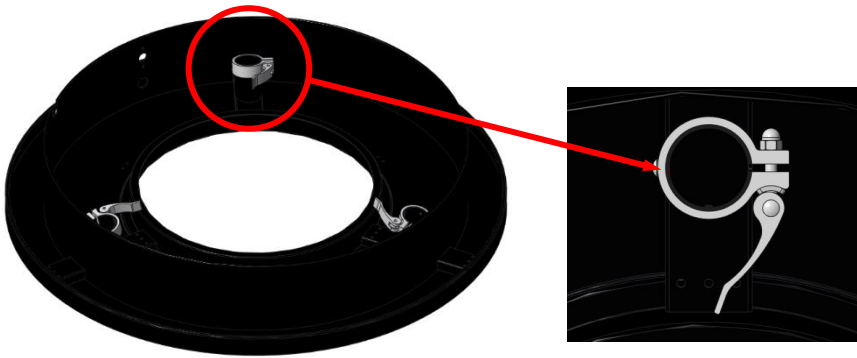

3. Insert the **Legs** into the openings attached to the **Base**. Listen for a click. This ensures that the securement pin on the **Legs** is in place. Repeat this process for each **Leg**.

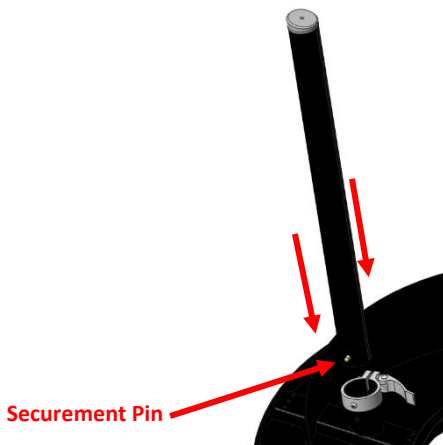

4. Once all **Legs** are securely attached to **Base**, move the clasps to the **closed** position.

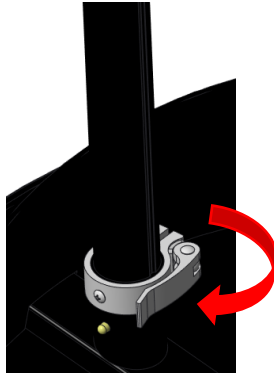

NOTE: Clasp arm can be rotated to adjust for tightness

5. Flip table into the upright position.



Gas Connections

Read and understand your Crystal Fire owner's manual before beginning burner hookups or using the device.

Do not use Teflon tape or pipe dope on flare fittings.

1. Attach natural gas supply line using a 3/8" flare fitting, or attach the included black rubber propane hose and regulator to the bottom fitting of the control valve.

TIGHTEN SECURELY WITH A WRENCH

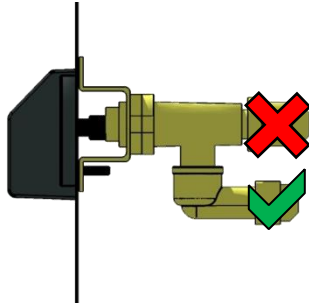
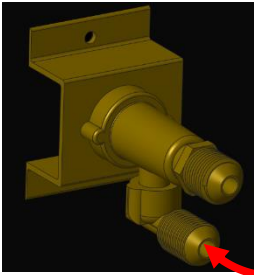

- Propane input
- Natural gas input



or

Natural gas supply line
as specified by local
building codes

2. Lay the burner upside down on a flat, soft surface to avoid scratching the polished metal. Ensure the correct orifice is installed for the fuel type you are using (see Crystal Fire user manual included with burner for orifice sizing information). Attach the included metal flex hose to the burner.

TIGHTEN SECURELY WITH TWO WRENCHES



3. Attach flex line from the burner to gas valve as shown below.

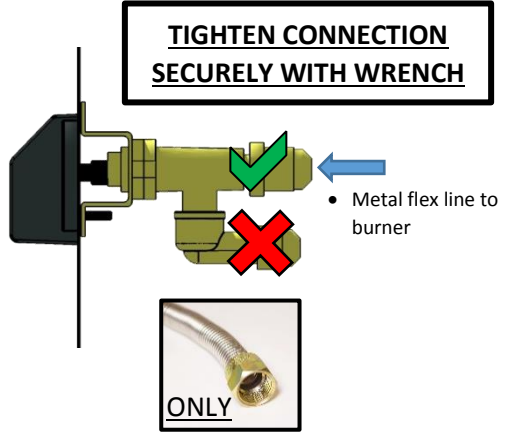
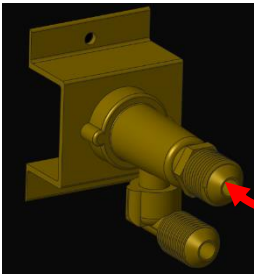

WARNING

Check all connections before each use when traveling with the table. This is to ensure no component has become loose during traveling or relocating the table.

CF-SPARKER Installation

1. Make sure the valve is in the **OFF** position before beginning.
2. Install CF-SPARKER as shown, using a AAA battery (not included). Negative end should be placed inside the CF-SPARKER, positive end outside of the CF-SPARKER.

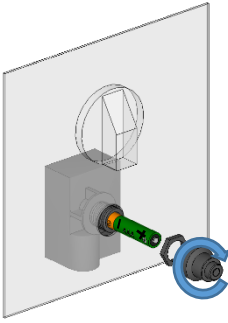

CF-SPARKER will not operate correctly without an ignition **and** ground wire attached.

- Plug both **BLACK** wires hanging from the burner into the back of the sparker box.

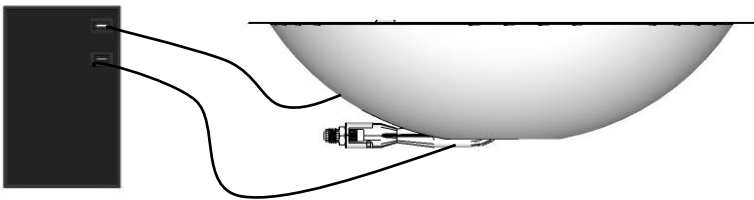

- **Before turning on gas, test CF-SPARKER by pushing the button on the igniter.** Consult the troubleshooting section of the Crystal Fire Owner's Manual if the spark is weak, intermittent, or not present.

Install Fire Media

1. Scatter all of the included **Glass Beads** evenly onto burner surface.

- **DO NOT OPERATE CRYSTAL FIRE BURNER WITHOUT GLASS BEADS OR OTHER DECORATIVE MEDIA PRESENT**

- **DO NOT OPERATE CRYSTAL FIRE BURNER WITH BURNER COVER OR FOAM PAD IN PLACE**



***NOTE*:** **Glass beads** can be left in place within the table for quicker set up for the next usage. See page 12 for storage information.

After installing CF-SPARKER and making gas connections, verify that all connections are tight and that no leaks are present using a solution of soapy water or a commercially available leak-check solution.

Position Your Tank (If Applicable)



1. Connect the propane hose/regulator to the propane tank and hand tighten (**DO NOT USE A WRENCH**)
2. With the tank under the table, ensure that no hoses, wires, or any other components are kinked or touching the burner pan.

WARNING

Locate the hose out of walk ways and inspect the hose for damages before each use.

Storage

Your Renegade Fire Table can safely be stored in its included carrying bag so it is ready to be quickly set up for the next use.

- 1. Ensure that control panel is in the off position and that the table is disconnected from the gas supply.**



Disconnect from gas supply and remove tank.

- 2. Insert Media Retention Pad into burner opening (media can be left in place).**

***NOTE*:** Allow 30 minutes for table to cool before inserting Media Retention Pad into table.



3. Position **Burner Cover** over top of **Media Retention Pad** so that all cover latches line up with latches on table

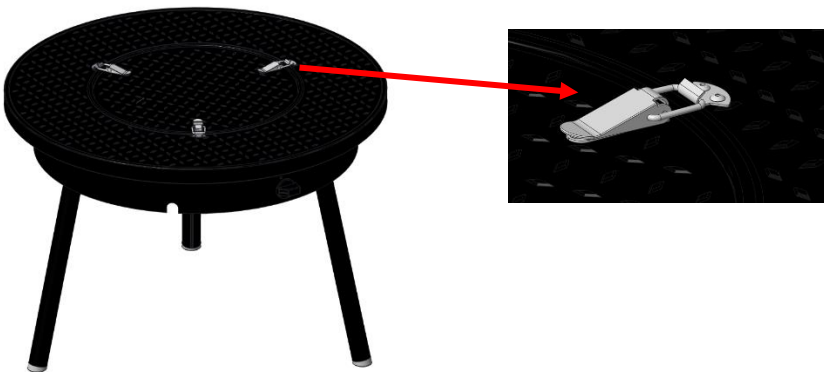

4. Close all top latches to secure **Burner Cover** in

Store legs within **Base** cavity.

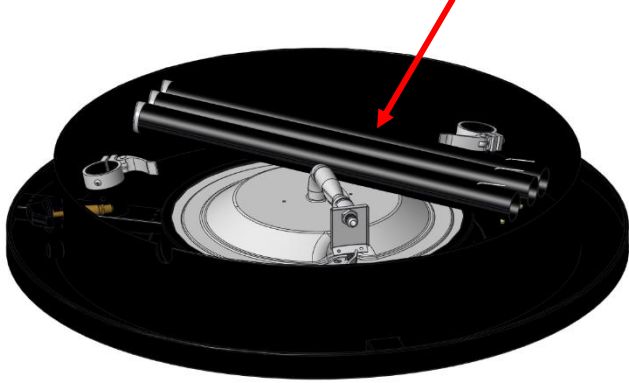

5. Collapse and remove all **Legs** from base latches.
Legs can be stored within cavity of **Base** as shown above.

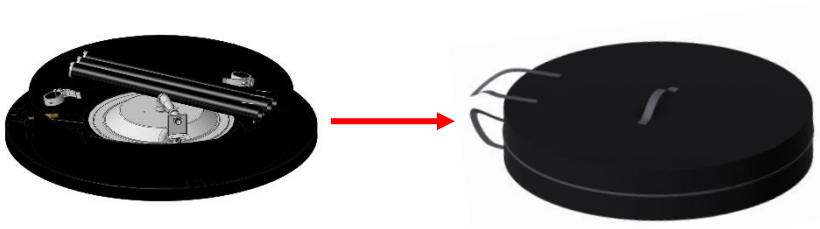

6. Place entire table assembly into **Carrying Bag** for easy storage.

REMINDER: Wait 30 mins before beginning the storage process.

IMPORTANT

Please consult your Crystal Fire instruction manual for detailed instructions and important information related to the burner installation including: lighting and operating instructions, safety information, and proper tightening of connections with two wrenches.

DO NOT ATTEMPT TO INSTALL CRYSTAL FIRE BURNER WITHOUT FIRST CONSULTING THE CRYSTAL FIRE OWNER'S MANUAL.

WARNING

After consulting the manual and following instructions, remember; before operating, all gas connections must be fully checked for leaks

Warranty: Fire pit tables are covered under a 1-year manufacturer's warranty. Please visit <http://www.outdoorrooms.com/warranty-form/> to register your product.



14400 Southcross Drive West • Suite 100 • Burnsville, MN 55306
Toll Free: 1-866-303-4028 • Sales@OutdoorRooms.com