

# 42" RUMFORD

UL 127 & ANSI Z21.60 COMPLIANT

## PRODUCT DIMENSIONS

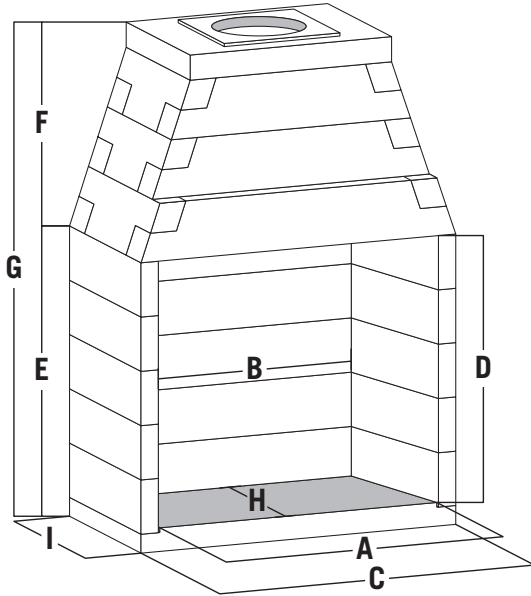

<b>WIDTH</b>	<b>A</b>	OPENING	44.5"
	<b>B</b>	FIREBOX REAR	34"
	<b>C</b>	OVERALL	50"
<b>HEIGHT</b>	<b>D</b>	OPENING	42.375"
	<b>E</b>	FIREBOX	46.125"
	<b>F</b>	SMOKE CHAMBER	31.5625"
	<b>G</b>	OVERALL	77.6875"
<b>DEPTH</b>	<b>H</b>	FIREBOX	22.5"
	<b>I</b>	OVERALL	28.5"
<b>DAMPER</b>		SIZE	36"
<b>WEIGHT</b>	UNIT: 2,650 LBS INSTALL KIT: 1,300 LBS		

All measurements listed are based on dry stack units before firebrick is installed.

Dimensions are nominal and are given for design and framing reference only.

Please consult the manufacturer's installation manual for all details and requirements before making a final design layout decisions.

## RECOMMENDED FRAMING DIMENSIONS

Dimensions add 0.5" of air space to the required clearances

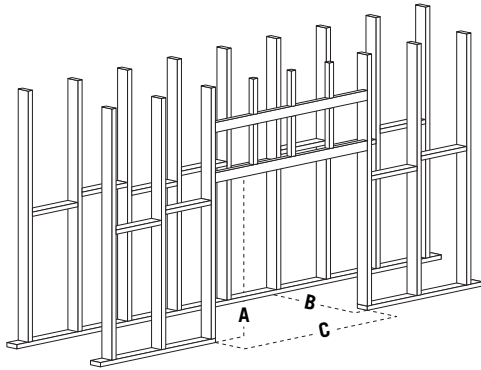

<b>A*</b>	<b>B</b>	<b>C</b>
56.3125"	30"	53"

\* It is recommended to not install framing header until after firebox is installed.

## CLEARANCE TO COMBUSTIBLES

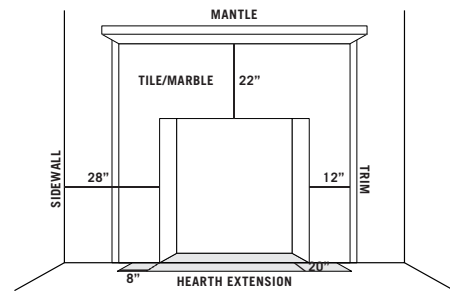

- **OPENING TO SIDEWALL:** 28"
- **OPENING TO COMBUSTIBLE TRIM:** 12"
- **OPENING TO MANTLE WITH 8" DEPTH:** 22"
- **NONCOMBUSTIBLE HEARTH EXTENSION:** 20" front; 8" each side
- **FIREBOX & SMOKE CHAMBER TO COMBUSTIBLES OR FRAMING:** 1"
- **SMOKE CHAMBER (FRONT WALL & TOP) TO WOOD FRAMING:** 1"

## AVAILABLE ACCESSORIES

- FireRock Adhesive Mortar (**MANDATORY**)
- Solid Block Chimney
- Offset Block
- Brick Flange
- Firebrick
- Crown Cap
- Height Extension Kit
- Outside Air Kit
- Installation Kit
- Damper
- Log Lighter
- LiteRock Riser
- UL 103 Metal Chimney (14")



**FR0542 - FIREROCK 42" RUMFORD**  
APPROVED FOR INDOOR & OUTDOOR USE

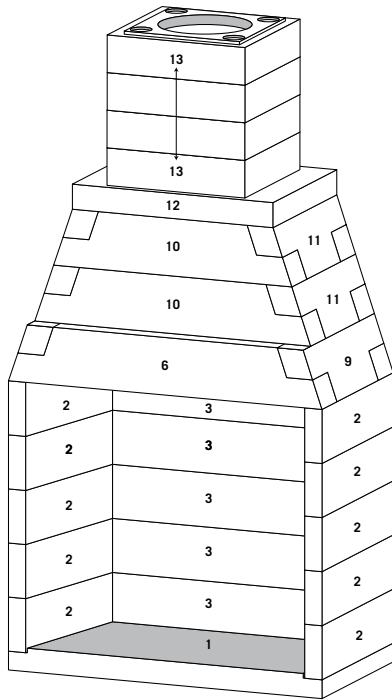

ISOMETRIC

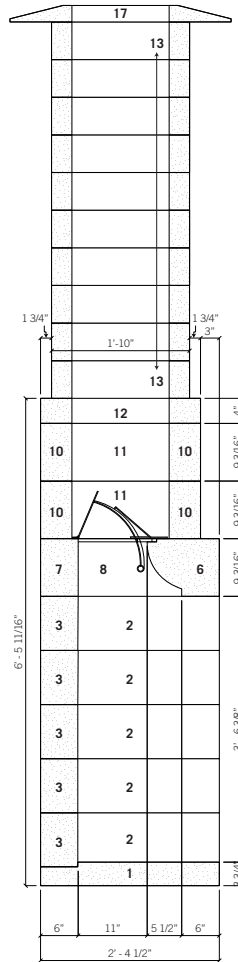

SECTION A-A

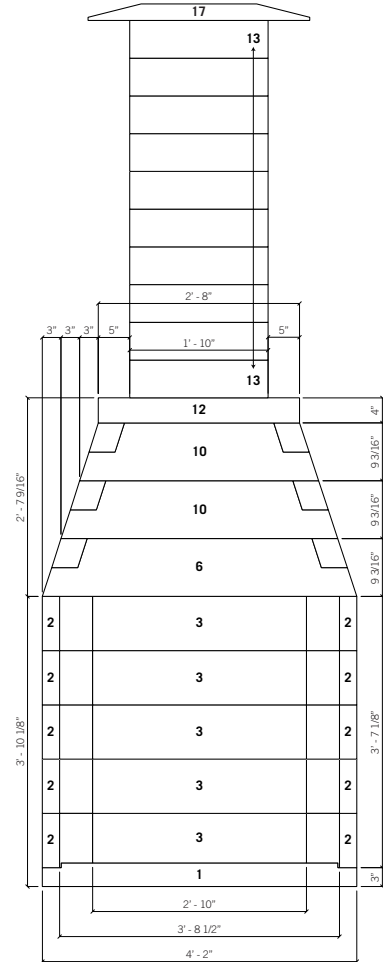

FRONT ELEVATION

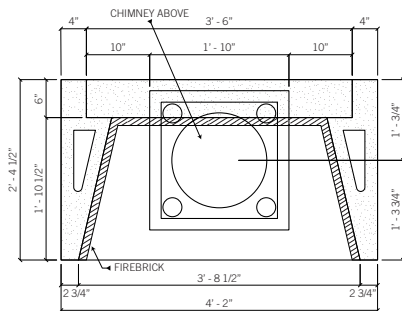

FIREBOX PLAN

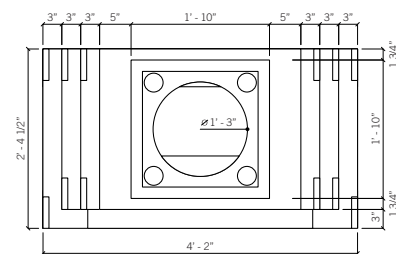

CHIMNEY PLAN

#	COMPONENT NAME
1	BASE PLATE
2	FIREBOX SIDE
3	STRAIGHT BACK BLOCK
6	RADIUS THROAT FRONT
7	SQUARE THROAT BACK
8	THROAT SIDE - LEFT
9	THROAT SIDE - RIGHT

#	COMPONENT NAME
10	SMOKE CHAMBER FRONT AND BACK
11	UNIVERSAL SMOKE CHAMBER SIDES
12	CHIMNEY BASE
13	CHIMNEY BLOCK
17	LARGE CROWN CAP

\*NOTE: All pieces subject to a 1/8" tolerance